

Modelo 3742-3749-UTILITARIA

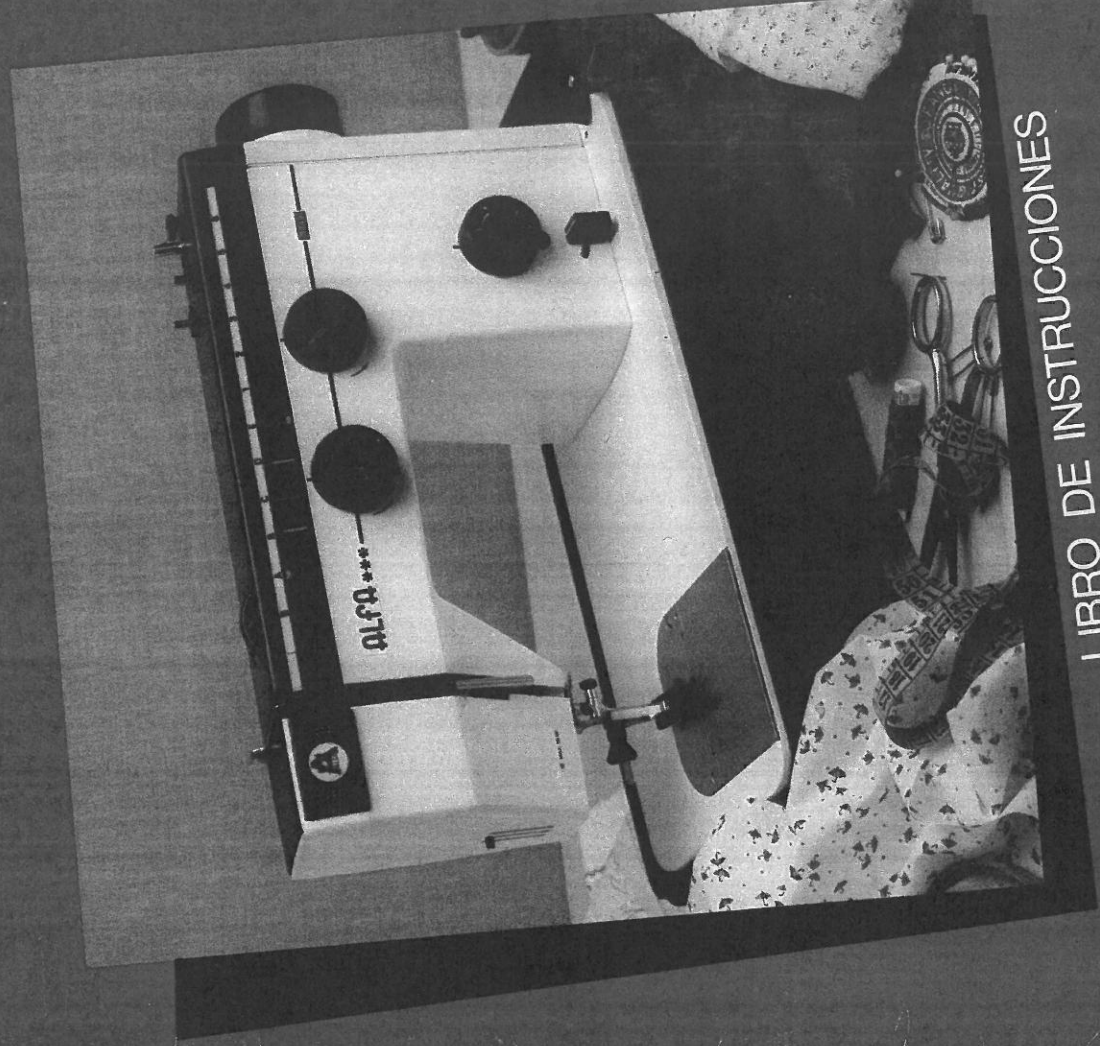

LIBRO DE INSTRUCCIONES

LO
AL

AGASALLOS

MÁQUINAS DE COSER

www.loalsalceda.com

Avda de Galicia 61
Salceda de Caselas, Pontevedra

NOMENCLATURA DE LAS PRINCIPALES PARTES DE LA MAQUINA

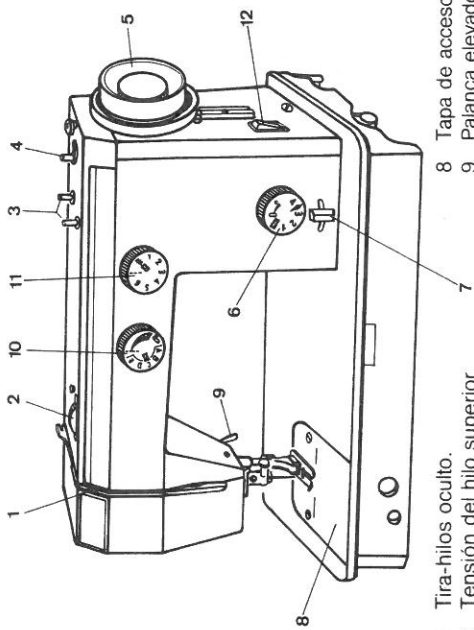

- 8 Tapa de acceso a la lanzadera.
 9 Palanca elevadora del prensateelas.
 10 Mando de ancho de zig-zag y ojeador automático.
 11 Mando selector de puntadas.
 12 Interruptor de luz.
- 1 Tira-hilos oculto.
 2 Tensión del hilo superior.
 3 Porta-carretes ocultables.
 4 Devanador.
 5 Volante.
 6 Mando de longitud de puntada.
 7 Mando de retroceso de puntada.

Fijación del pie prensateelas

Elevar la barra prensateelas por medio de la palanca situada en la parte posterior de la máquina.
 Para los prensateelas normales de pie intercambiables hacer un ligero movimiento basculante hacia abajo y retirar el pie.
 Para colocar otro pie posicionar éste bajo el empujador y bajar la palanca de la barra prensateelas para asegurar su fijación.
 Para los prensateelas especiales el cambio se hace por medio del tornillo de fijación.

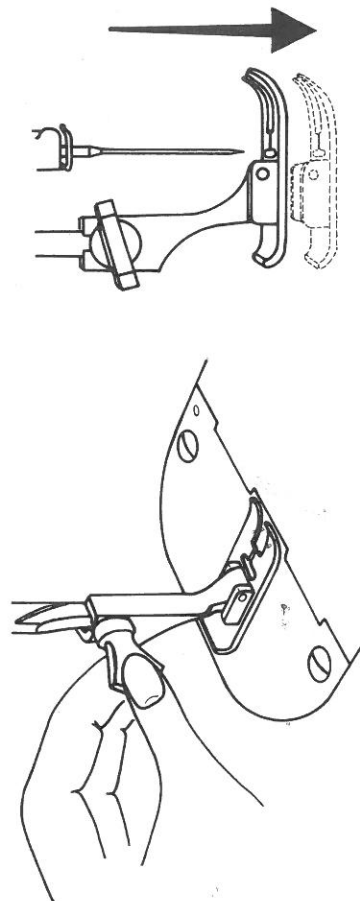

LOAL
 AGASALLOS
 MÁQUINAS DE COSER
www.loalsalceda.com
 Avda de Galicia 61
 Salceda de Caselas, Pontevedra

Colocación de la aguja

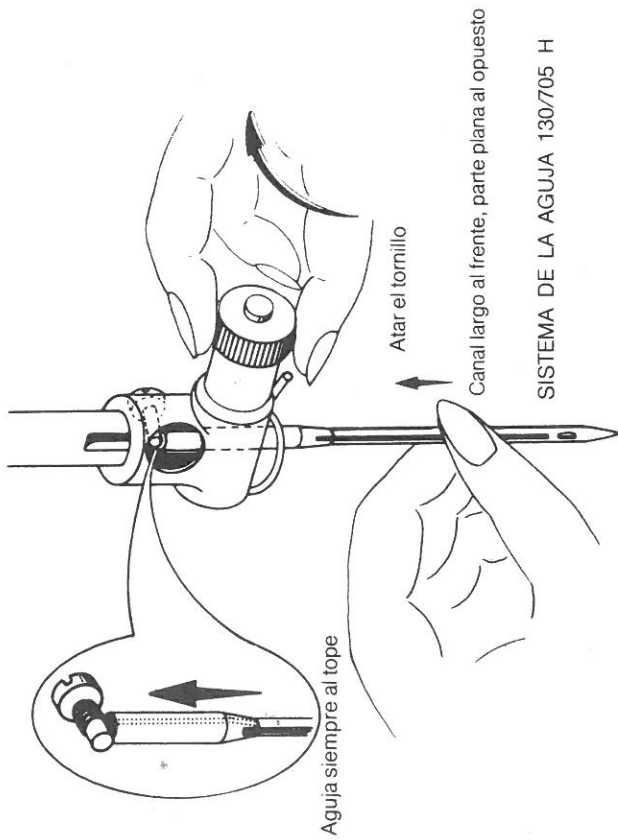

Devanado del hilo de la canilla

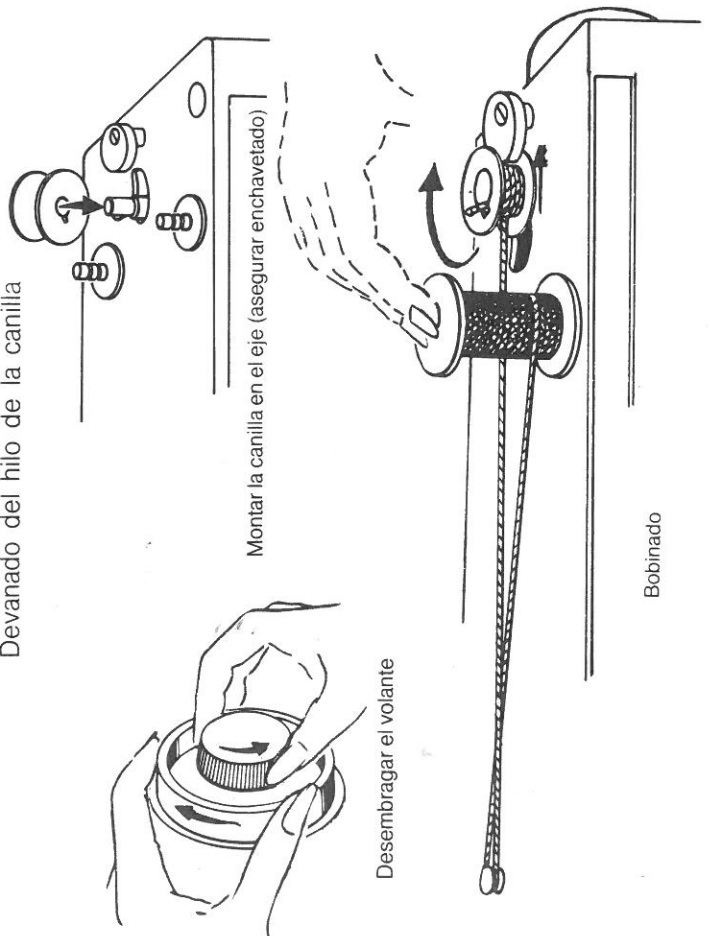

Introducción de la canilla en la cápsula

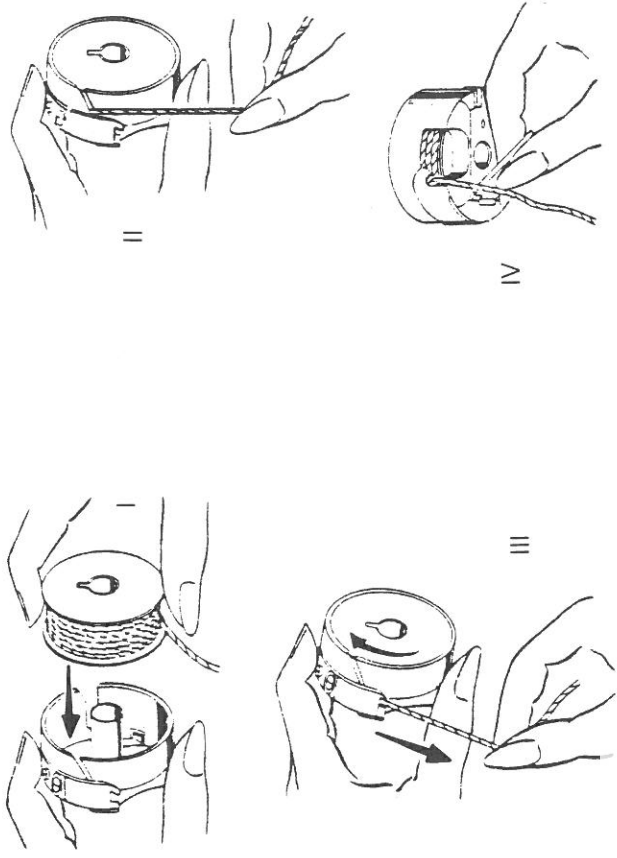

Montaje de la cápsula en la lanzadera

LOAL
AGASALLOS

MÁQUINAS DE COSER

www.loalsalceda.com

Avda de Galicia 61

Salceda de Caselas, Pontevedra



Tensiones del hilo, superior e inferior

Tensado hilo superior -
Tensar (+); Aflojar (-)

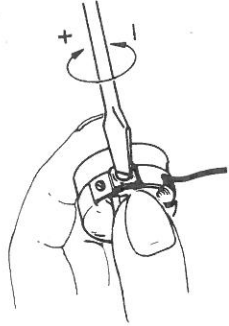
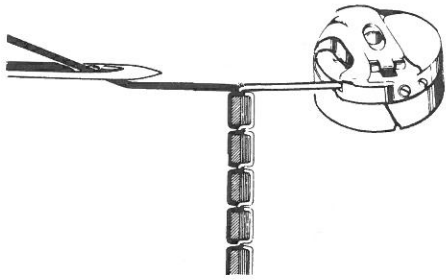
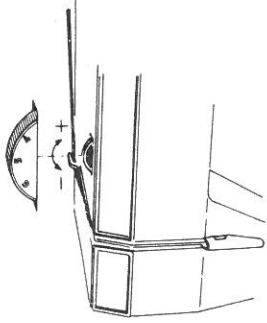

Tensado hilo inferior - Tensar (+); Aflojar (-)

Final de costura

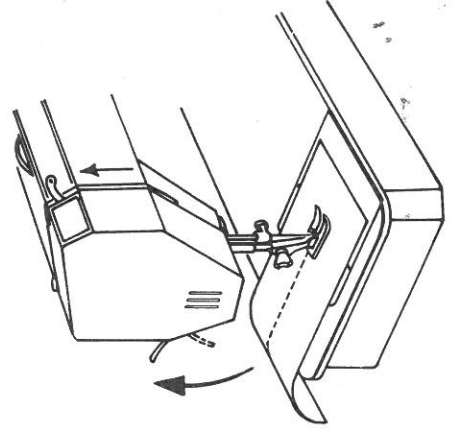

Subir prensatelas

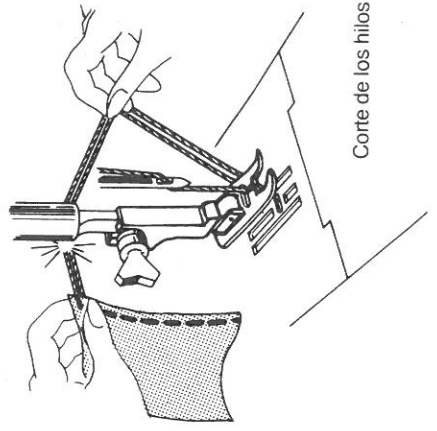

Corte de los hilos

LOAL

AGASALLOS

MÁQUINAS DE COSER

www.loalsalceda.com

Avda de Galicia 61
Salceda de Caselas, Pontevedra

Enhebrado del hilo superior

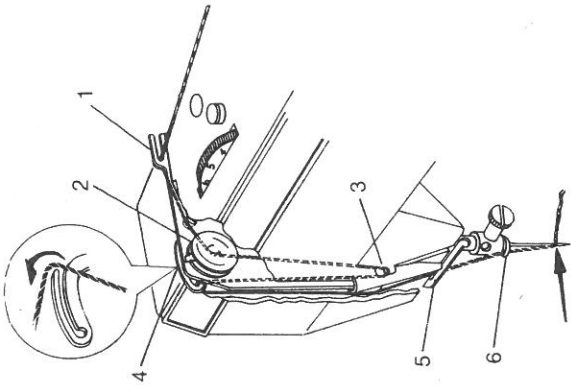

Enhebrar la aguja

Extracción del hilo inferior

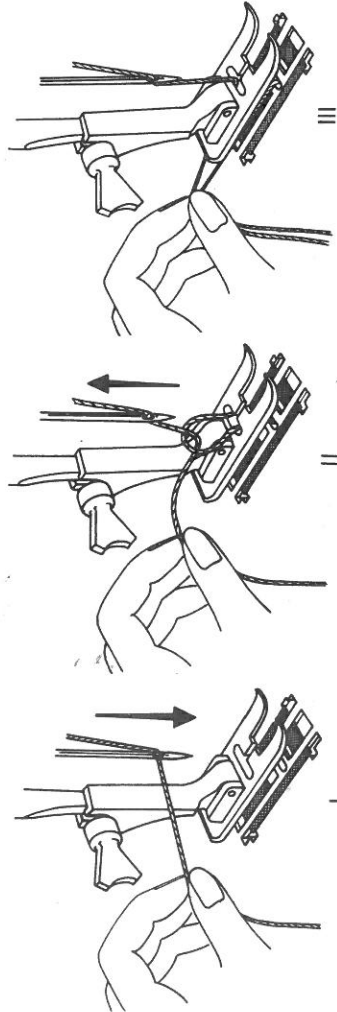

SELECCION DE LABORES

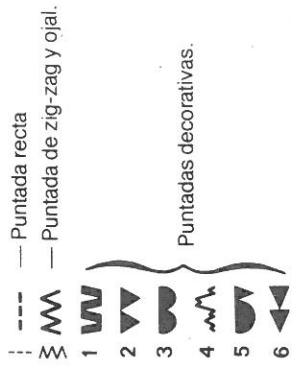
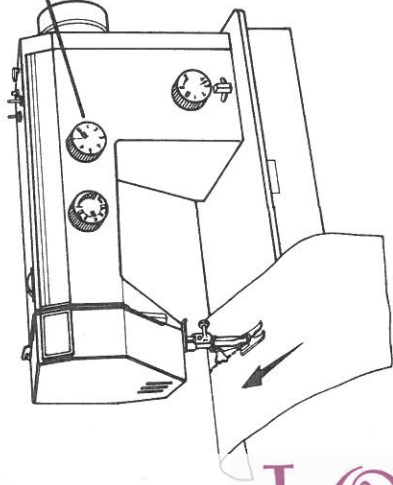
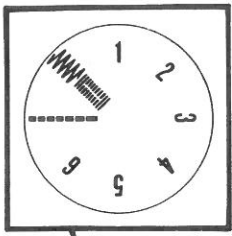

LOAL

AGASALLOS

MÁQUINAS DE COSER

www.loalsalceda.com

Avda de Galicia 61

Salceda de Caselas, Pontevedra

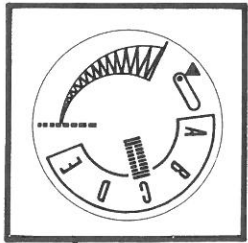

MANDO DE ANCHO DE ZIG-ZAG, OJALADOR AUTOMÁTICO Y POSICION DE LA AGUJA A LA IZQUIERDA.

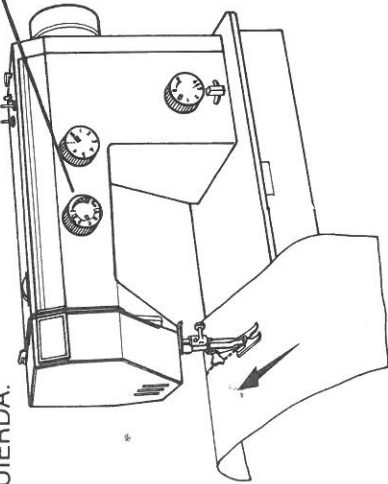

Para obtener el ancho de zig-zag girar el mando a la posición deseada.
 Para costura en puntada recta de generos difíciles, situar la aguja en la posición izquierda.
 Para ejecutar el ojal, ver pag. 13

MANDOS REGULADOR DE PUNTADA Y DE RETROCESO

Para obtener la longitud de puntada deseada, girar el mando, de 0 a 4

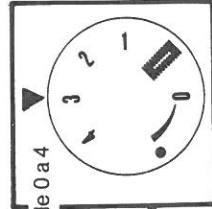

Costura hacia adelante de 0 a 4

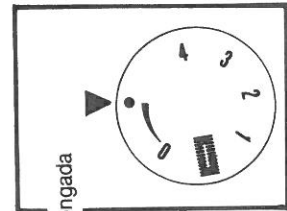

Costura prolongada hacia atrás

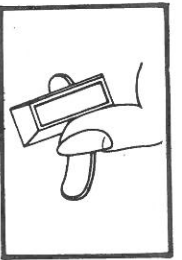
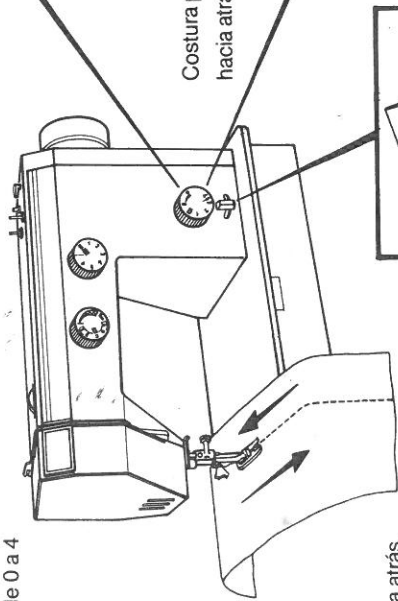

Costura hacia atrás.
 Pulsar el mando de retroceso de puntada según indica la figura.

Cuando se deja de pulsar el mando, la máquina vuelve automáticamente a costura en avance.

APLICACIONES DE COSTURA CON DOBLE AGUJA

Aguja doble

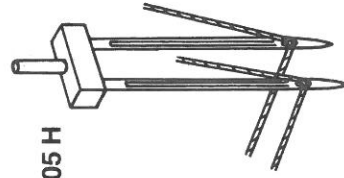

Sistema 130-705 H

NE 2.80



n° 1.84218

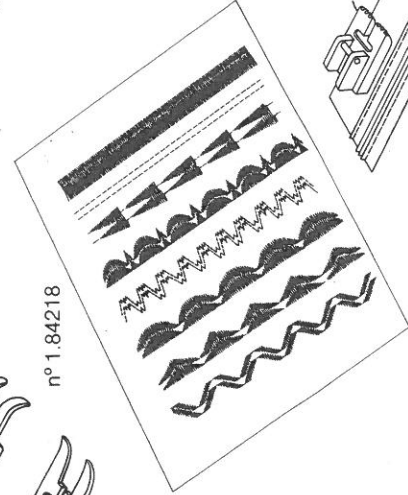

n° 1.84222

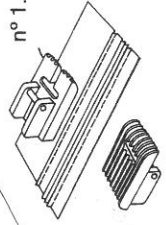

Pie para nervuras

COSTURA NORMAL
EN PUNTADA RECTA

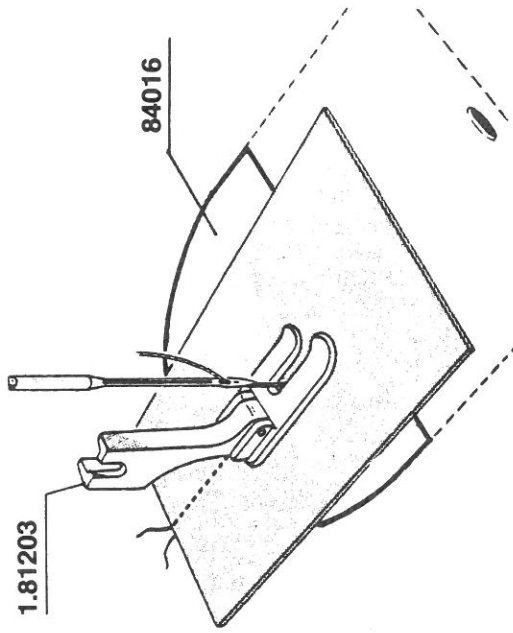

LOAL

AGASALLOS

MÁQUINAS DE COSER

www.loalsalceda.com

Avda de Galicia 61

Salceda de Caselas, Pontevedra

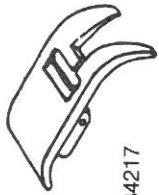

n° 1.84217

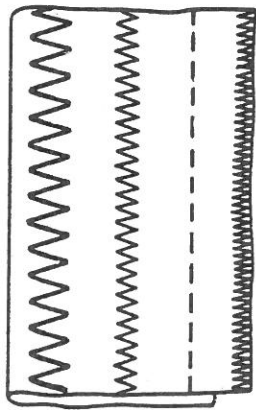

Costura de puntada recta y zig-zag
Sobrehilado rápido

Puntada de realce

n° 1.84218

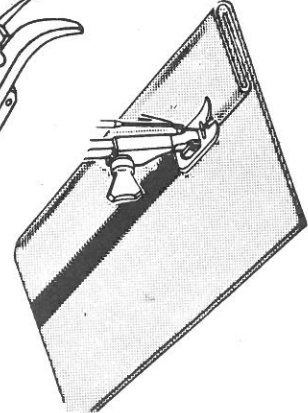

Cierre de cremallera y acolchado

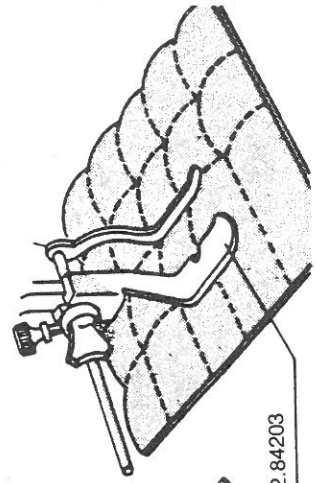

Acolchado

2.84203

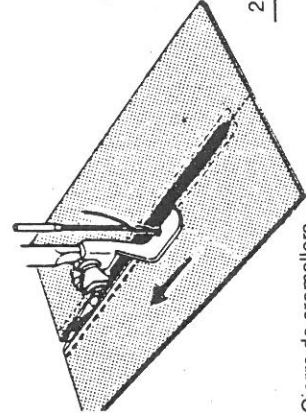

Cierre de cremallera

Regla guía de tejido

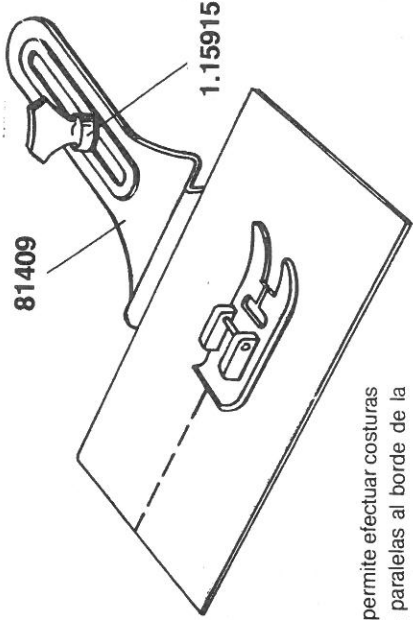

Esta guía de tejido, permite efectuar costuras de cualquier clase, paralelas al borde de la tela.

La distancia que desee entre la costura y el borde del tejido, puede fijarla atando la regla guía en la posición que convenga.

Fruncidos

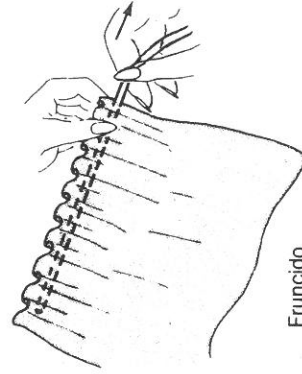

Fruncido

Fruncido con hilo elástico

Costuras decorativas

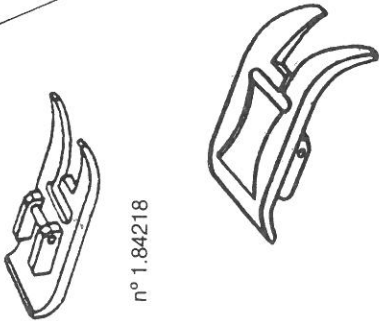
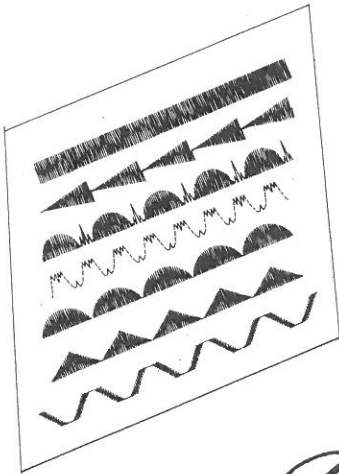

n° 1.84218

LOAL
 AGASALLOS
 MÁQUINAS DE COSER
www.loalsalceda.com
 Avda de Galicia 61
 Salceda de Caselas, Pontevedra

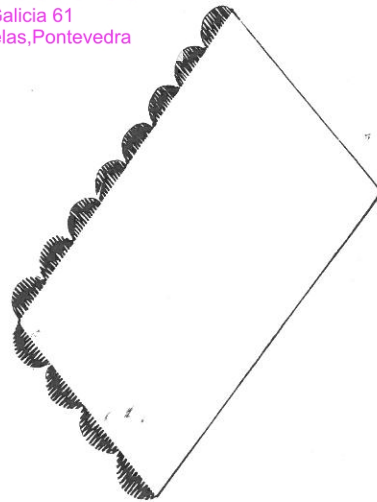

Aplicación de festones

Pies para nervuras y cordoncillo

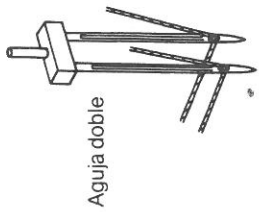

Aguja doble

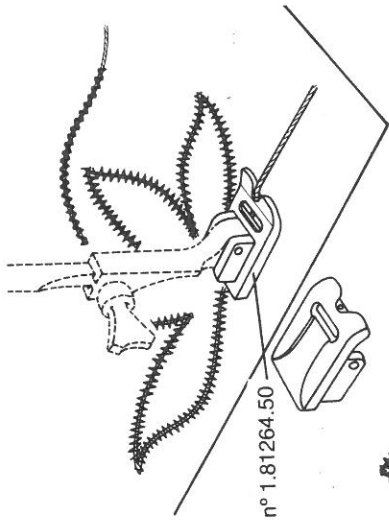

nº 1.81264.50

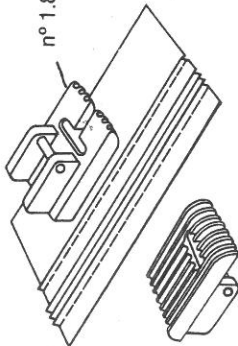

nº 1.84222

Pie para nervuras

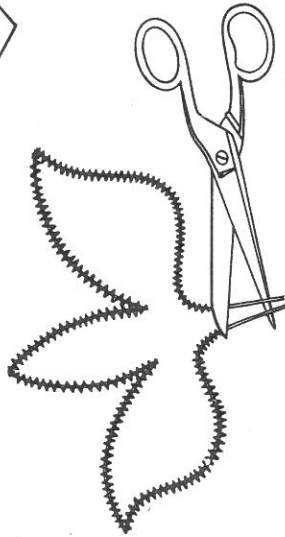

Monogramas y aplicaciones

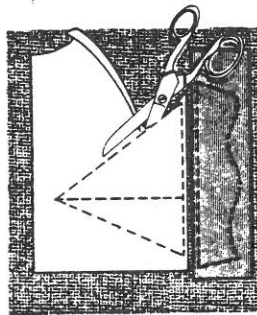

Aplicaciones

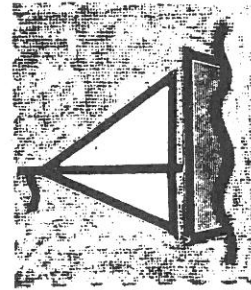

nº 1.84218

LOAL

AGASALLOS
MÁQUINAS DE COSER
www.loalsalceda.com
Avda de Galicia 61
Salceda de Caselas, Pontevedra



Monogramas

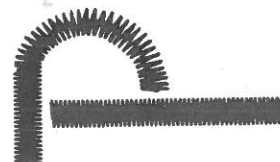

Ojal automático

Posiciones del mando ojalador



nº 1.84220

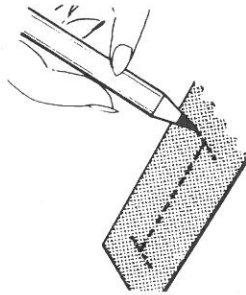

Marcado para el ojal

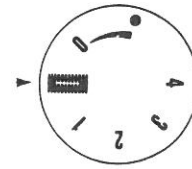

Con la aguja arriba, girar el mando hasta A y coser la presilla. (Eleva siempre la aguja antes de girar el mando).

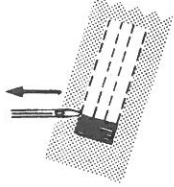
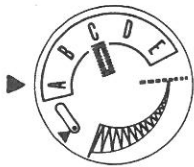

Girar hasta B y coser el labio. Elevar la aguja.

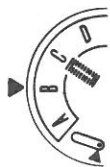

Girar hasta C y coser puntada recta en retrocreso, para posicionar la aguja. Elevar la aguja.

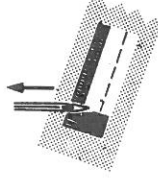
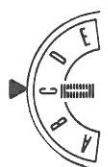

Girar hasta D y coser el segundo labio. Elevar la aguja.

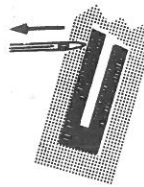

Girar hasta E y coser la segunda presilla. Elevar la aguja.



Girar hasta puntada recta y rematar. Elevar la aguja.



Posición del mando regulador de puntada (Entre 0 y 1)

1.89101



Abrir el ojal con el cortador.

Ojal con cordoncillo

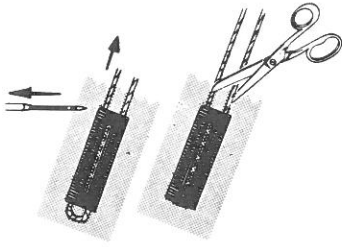

nº 1.84220

Cosido de botón

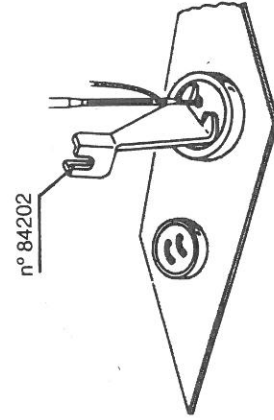
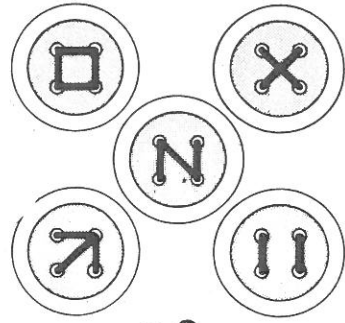

nº 84202

LOAL

AGASALLOS

MÁQUINAS DE COSER

www.loalsaiceda.com

Avda de Galicia 61

Salceda de Caselas, Pontevedra

Costura sobre jersey y aplicación de puntilla, recubrimiento de un elástico y costura de una cinta elástica.

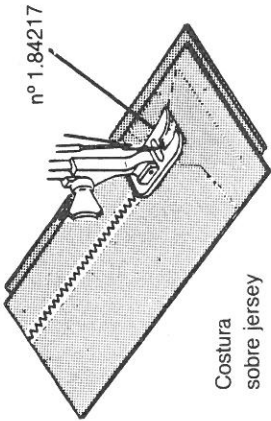

nº 1.84217

Costura sobre jersey

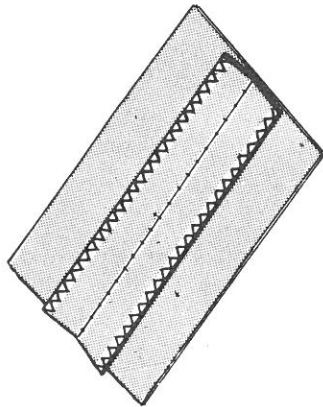

Colocación de puntilla

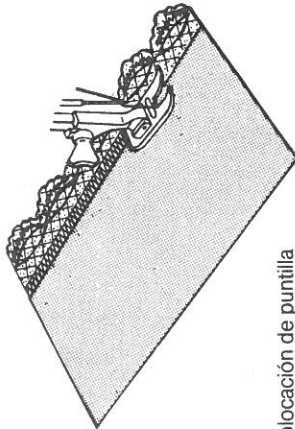

Recubrimiento de un elástico

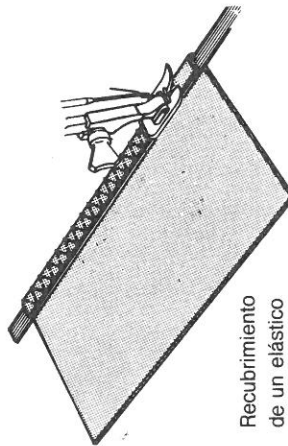

nº 1.84217

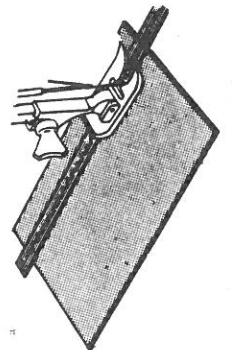

Costura de una cinta elástica

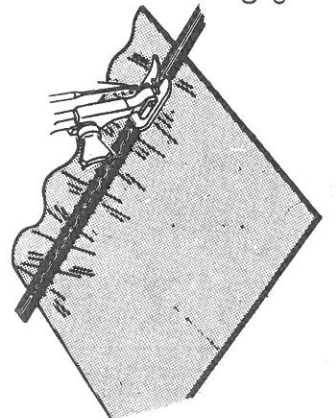

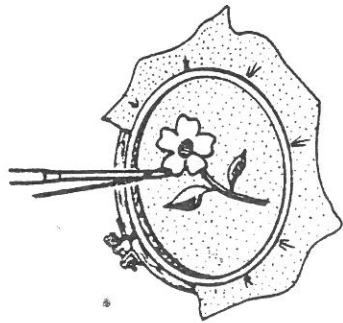

Bordado decorativo



n° 84401

Chapilla anuladora del arrastre de la tela

Puntada invisible elástica

1.84204

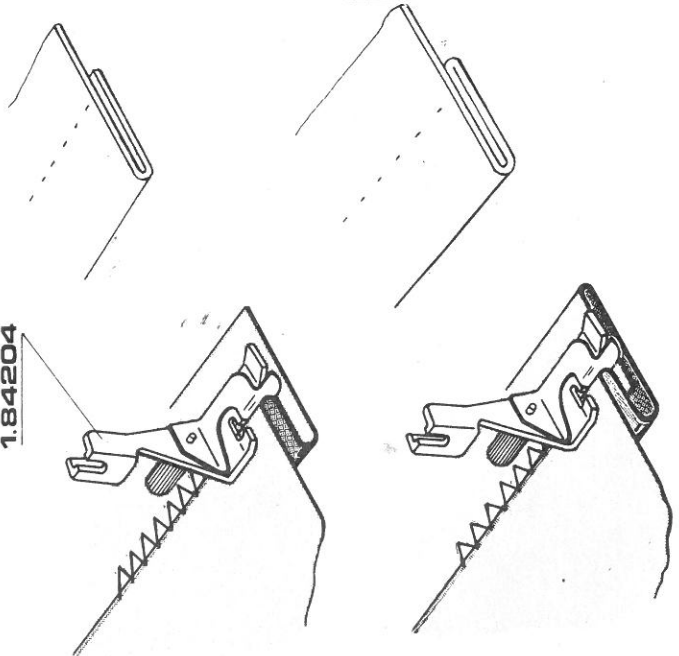

AGASALLOS
MÁQUINAS DE COSER
www.loalsalceda.com
Avda de Galicia 61
Salceda de Caselas, Pontevedra

LOAL

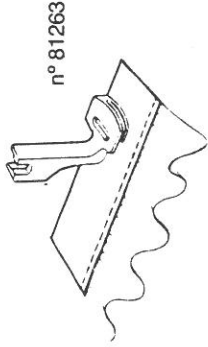

Pie fruncidor

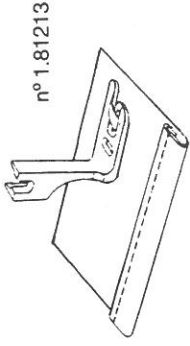

Pie dobladillador

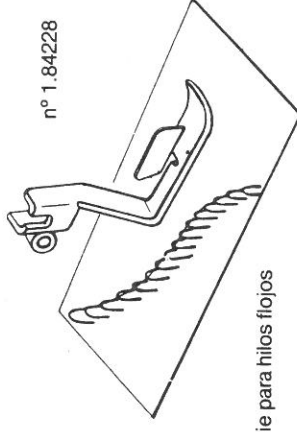

Pie para hilos flojos

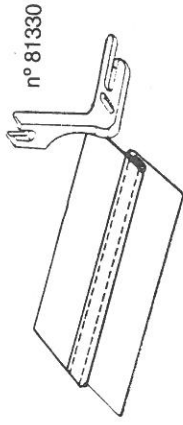

Pie plegador

Cambio de la lámpara

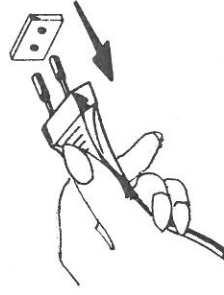
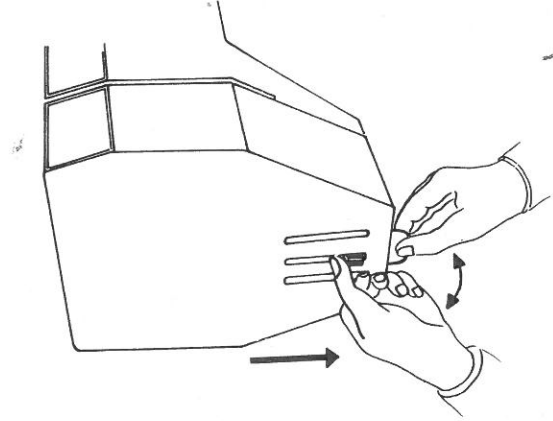

MAX 15W
220 V. 120 V.

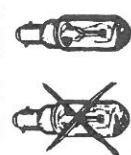

MAX 15W
220 V. 120 V.

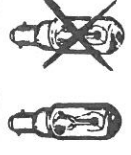

Limpeza y engrase

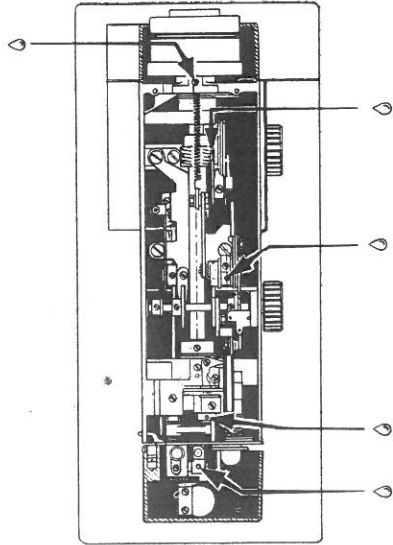

Engrase

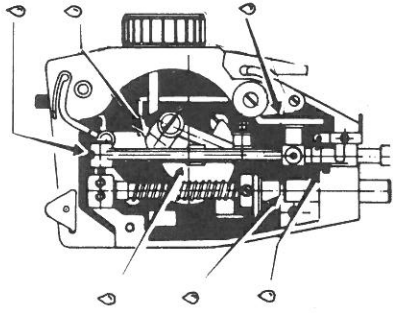

LOAL
 AGASALLOS
 MÁQUINAS DE COSER
www.loalsalceda.com
 Avda de Galicia 61
 Salceda de Caselas, Pontevedra

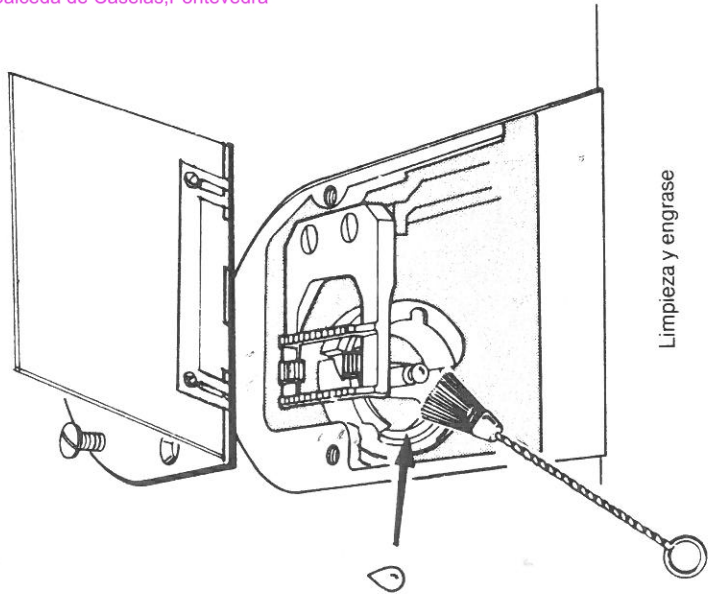

Limpeza y engrase

NOTAS
 NOTES
 NOTES
 NOTIZEN
 NOTE
 NOTITIES
 APONTAMENTOS